



## ARP-5517AX-E01-007-DR

NEMA 4X Waterproof Thin Client Panel PC with 17-inch Touch Screen



### Features

- 17" LCD, 1280 x 1024 Resolution
- 5-Wire Resistive Touch
- Stainless Steel Enclosure
- Meets NEMA 4X requirements
- Intel Celeron J1900 @ 1.99GHz / Atom E3845 @ 1.91GHz CPU
- 4GB DDR3 SO-DIMM
- Gigabit Ethernet
- 2x USB 2.0 ports
- Optional UL Class 1 Division 2 of Hazardous Area Approved Configuration can Prevent Combustible Dust Explosion

### Specifications

Model Name	ARP-5517AX-E01-007-DR
<b>LCD Display</b>	
Display Size (Diagonal)	17.0 inch
Resolution	1280 x 1024
Backlight Lifetime (Hours)	50,000 hours
<b>Visual Characteristics</b>	
Colors	16.7 million
Aspect Ratio	5:4
Viewing Angle (V/H)	160° / 140°
Contrast Ratio	800 : 1
Brightness	350 nits
<b>Touchscreen</b>	
Technology	5 Wire Resistive
Interface	USB x 2
Driver	ThinManager Supported Driver
<b>Enclosure</b>	
NEMA 4	N/A
NEMA 4x	Stainless Steel
<b>System</b>	
CPU	Intel Celeron J1900 @ 1.99GHz / Atom E3845 @ 1.91GHz CPU
Chipset	Bay Trail
Memory	4GB DDR3 SO-DIMM
Video Controller	Intel Gen7 Intel Graphics DX 11, OGL3.2
External Video Output	N/A
Storage Option	N/A
Compact Flash	N/A
Keyboard / Mouse	USB
Audio	N/A
Watchdog Timer	Programmable 1 - 255 sec
Remote Boot	ThinManager Ready, PXE
Expansion Slot	N/A
<b>I/O Communication</b>	
USB Port	2 x USB 2.0
Serial Port	N/A
IEEE 1394	N/A
LAN	1 x Gigabit
Parallel	N/A
GPIO	N/A
<b>Smart Battery</b>	
External Smart Battery	N/A
<b>OS Support</b>	
OS Support	N/A
<b>Power/Thermal Specs</b>	
Power Requirement (Max)	24VDC / 1.25A
Power Consumption (Max)	30 W
Recommended Power Supply	43 W
Heat Dissipation	103 BTU/hr
<b>Physical Information</b>	
Mounting	Pedestal, VESA, Wall and Ceiling mount, Benchtop
Net Weight	34 Lbs / 15.42 Kg
Dimension (W x H x D)	15.88 x 14.07 x 4.36 inch 403.4 x 357.4 x 110.7 mm
Recommended Cutout Dimension (WxH)	N/A
<b>Environmental</b>	
Operating Temperature	0~50°C (32~122°F)
Storage Temperature	-20~60°C (-4~140°F)
Relative Humidity	0~95%
IP/NEMA Rating	Meets NEMA 4X
Certification	N/A

## Dimension Drawing

Model Name: ARP-5517AX-E01

Size Unit: inch(mm)

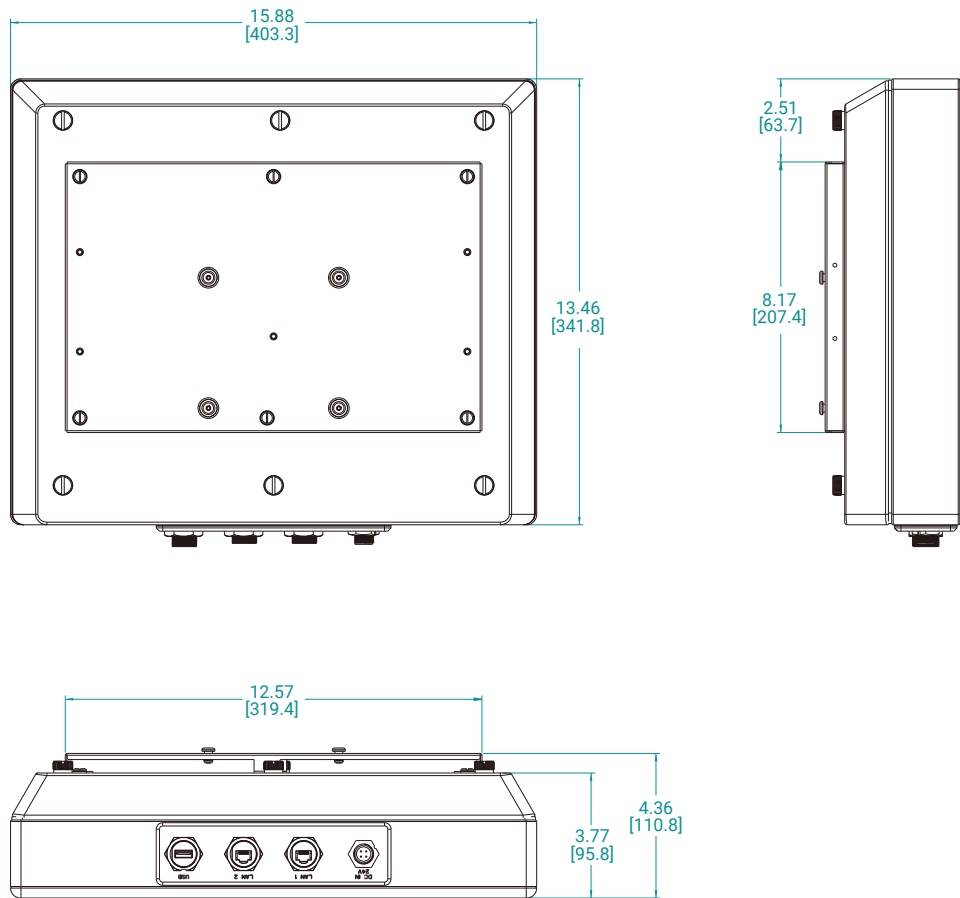

## Ordering Information

Item	ARP-5517AX-E01-006	ARP-5517AX-E01-007
LCD Display	17.0" LCD / 1280 x 1024	17.0" LCD / 1280 x 1024
Touch Screen	5-Wire	5-Wire
Enclosure	Stainless Steel	Stainless Steel
CPU	Intel Celeron J1900 @ 1.99GHz / Atom E3845 @ 1.91GHz CPU	Intel Celeron J1900 @ 1.99GHz / Atom E3845 @ 1.91GHz CPU
Memory	4GB DDR3	4GB DDR3
Storage	N/A	N/A
Remote Boot	ThinManager Ready	ThinManager Ready
Power Supply	24VDC Input	110/220VAC Input DIN-Rail

Item	ARP-5517AX-E01-006-C1D2
LCD Display	17.0" LCD / 1280 x 1024
Touch Screen	5-Wire
Enclosure	Stainless Steel
CPU	Intel Celeron J1900 @ 1.99GHz / Atom E3845 @ 1.91GHz CPU
Memory	4GB DDR3
Storage	N/A
Remote Boot	ThinManager Ready
Power Supply	24VDC Input
Hazardous Location	c UL C1D2 Certification